

Smart LifestyleTM

A U S T R A L I A

INSTALLATION & USER MANUAL

Air to Water Heat Pump Water Heater

All-in-one type

SMART LIFESTYLE AUSTRALIA PTY LTD

Email: service@smartlifestyleaustralia.com.au

Thank you very much for purchasing our product.
Before operating your unit, please read this manual carefully and keep it for future reference.

WARNING



Installation to conform with AS/NZS 3500.4

WARNING



The heat pump unit requires a reliable earthing connection before usage; otherwise it might cause death or injury. 

If you cannot confirm that your house power supply is earthed well, please do not install the unit before carefully check it. Please have a qualified person to check the reliable earthing connection and install the unit.

Examples of a qualified person include: Licensed plumbers, Authorized electric company personnel, and Authorized service personnel.



WARNING

- IF THE HOT WATER SYSTEM IS NOT USED FOR TWO WEEKS OR MORE, A QUANTITY OF HIGHLY FLAMMABLE HYDROGEN GAS MAY ACCUMULATE IN THE WATER HEATER. TO DISSIPATE THIS GAS SAFELY, IT IS RECOMMENDED THAT A HOT TAP BE TURNED ON FOR SEVERAL MINUTES OR UNTIL DISCHARGE OF GAS CEASES. USE A SINK, BASIN, OR BATH OUTLET, BUT NOT A DISHWASHER, CLOTHES WASHER, OR OTHER APPLIANCE. DURING THIS PROCEDURE, THERE MUST BE NO SMOKING, OPEN FLAME, OR ANY ELECTRICAL APPLIANCE OPERATING NEARBY. IF HYDROGEN IS DISCHARGED THROUGH THE TAP, IT WILL PROBABLY MAKE AN UNUSUAL SOUND AS WITH AIR ESCAPING.
- WARNING - THIS APPLIANCE MAY DELIVER WATER AT A HIGH TEMPERATURE. REFER TO THE PLUMBING CODE OF AUSTRALIA (PCA), LOCAL REQUIREMENTS AND INSTALLATION INSTRUCTIONS TO DETERMINE IF ADDITIONAL TEMPERATURE CONTROL IS REQUIRED.
- WARNING - FOR CONTINUED SAFETY OF THIS APPLIANCE IT MUST BE INSTALLED, OPERATED AND MAINTAINED IN ACCORDANCE WITH THE MANUFACTURER'S INSTRUCTIONS.

Part names:

SLA-R18-190D/N3A4

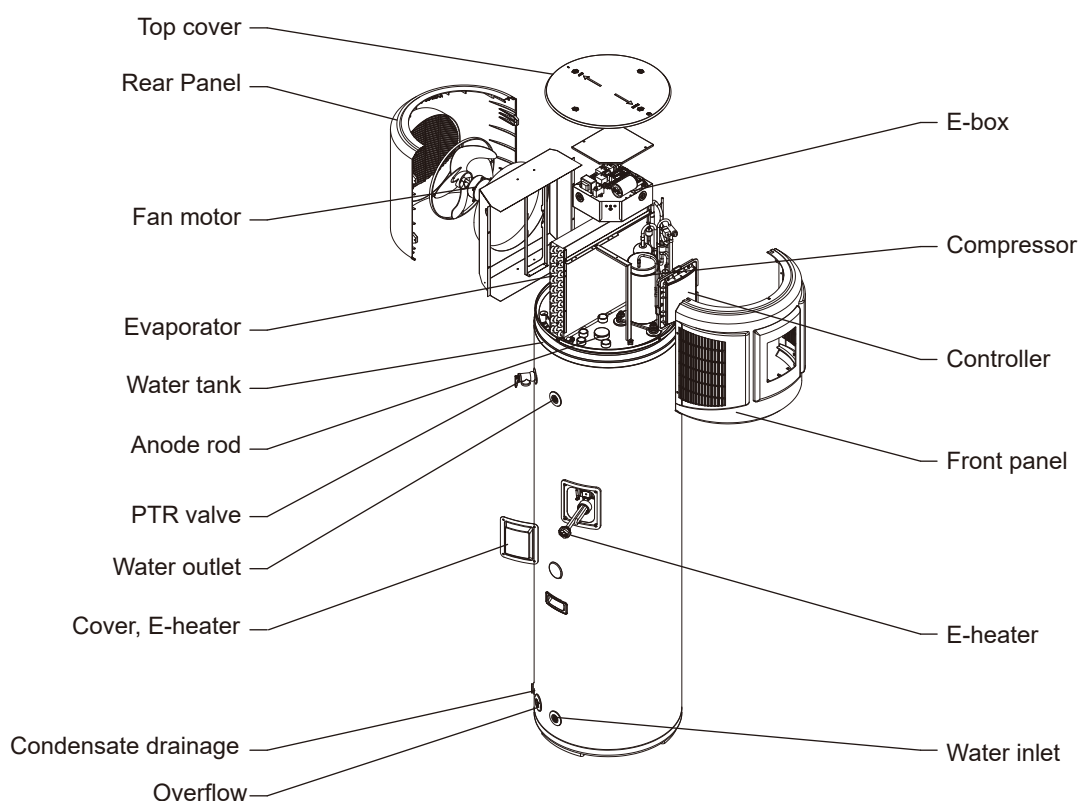

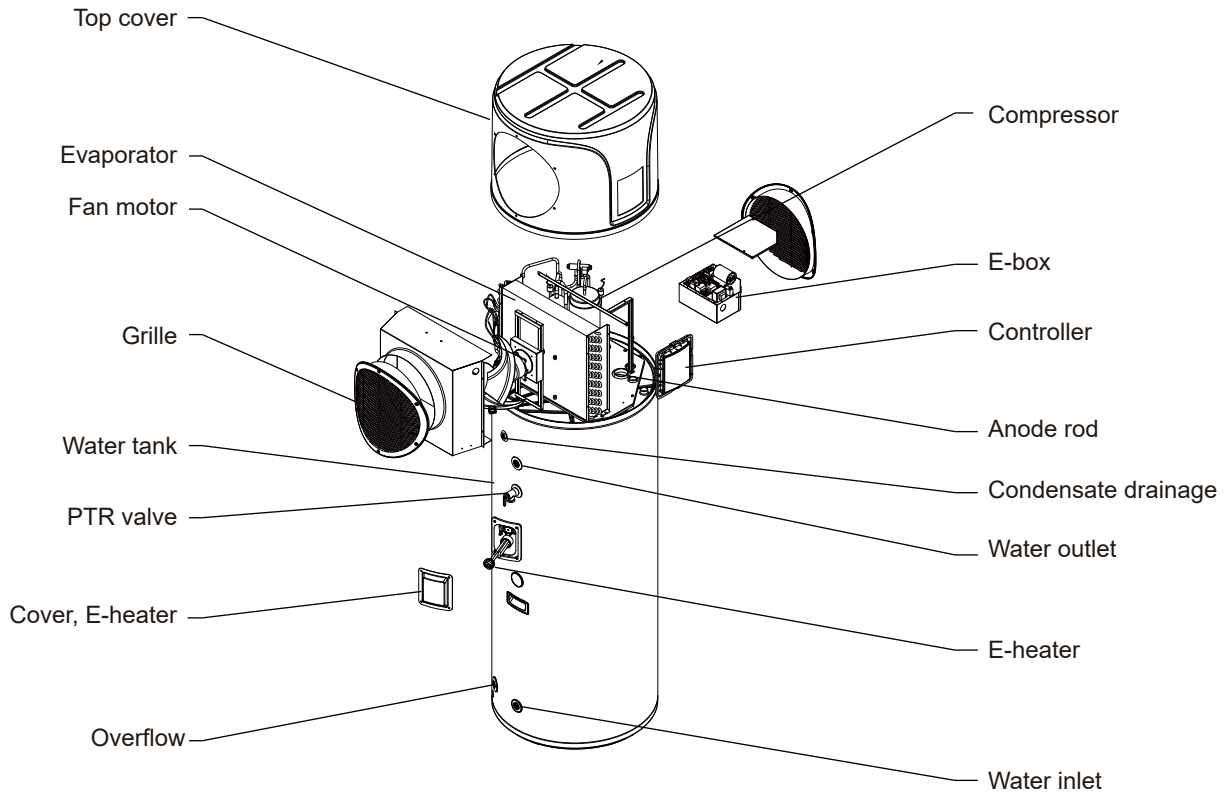

SLA-R25-300D/N3D4 SLA-R25-300D/N3D4C



Contents	Pages
1. Safety information	02
2. Preparation of installation	04
3. Installations	07
4. Trial-running	11
5. Operation	12
6. Troubleshooting	18
7. Maintenance	20
8. Specifications	21

1. Safety information

Please carefully read thoroughly all of the instructions before installing or operating the unit.
Following safety symbols are very important, please carefully read and always obey all safety symbols.

	CAUTION	If the precaution is not taken, it may cause minor or moderate injury
	WARNING	If the warning is not heeded, it can cause death or serious injury.
	DANGER	If the danger is not avoided, it will cause death or serious injury



WARNING

- For stationary appliances permanently connected to the fixed wiring, compliance with this requirement is considered to be met if the instruction concerning disconnection incorporated in the fixed wiring is in accordance with AS/NZS 3000.
- The unit must be earthed effectively and reliably.
- A residual current operated circuit-breaker (RCCB) must be installed adjacent to the power supply.
- Do not remove, cover or deface any permanent instructions, labels or the data labels from either the outside of the unit or inside of unit panels.
- Only the qualified person can perform the installation of this unit in accordance with local national regulations and this installation manual. Improper installation may result in water leakage, electric shock or fire.
- Only the qualified person can relocate, repair and maintain the unit. Improper installation and repairing may result in water leakage, electric shock or fire.
- Electric connection work should obey the instructions of local power company, local electric utility and this manual.
- Never use the wire and fuse with wrong rated current, otherwise unit may breakdown and cause fire furthermore.
- Do not insert fingers, rods or other objects into the air inlet or outlet. When the fan is rotating at high speed, it will cause injury.
- Never use a flammable spray such as hair spray, lacquer paint near the unit, because it may cause a fire.
- The heat pump unit is not intended for use by persons (including children) with reduced physical, sensory or mental capabilities, or lack of experience and knowledge, unless they have been given supervision or instruction concerning use of the unit by a person responsible for their safety. Children should be supervised to ensure that they do not play with the unit.
- Once the power supply cord is damaged, it must be replaced by service agent or the manufacturer or a similarly qualified person.
- Do not dispose this unit as unsorted municipal waste. Collection of such waste separately for special treatment is necessary.



Do not dispose of electrical appliances as unsorted municipal waste, use separate collection facilities. Please contact local government for information regarding the collection systems available.

If electrical appliances are disposed of the landfills or dumps, hazardous substances can leak into the groundwater and get into the food chain, damaging your health and well-being.



CAUTION

- The ground wire's pole of socket must be grounded well, make sure that power supply socket and plug are dry and connected well.
- To check the power supply socket and plug are qualified -
 - Step 1: Turn on the power supply.
 - Step 2: Keep the unit running for a half hour.
 - Step 3: Turn off the power supply and plug out.
 - Step 4: Check whether the socket and plug is hot or not.
- Before cleaning, be sure to stop the operation and turn the breaker off or pull out the power supply plug. Otherwise, an electric shock and injury may be caused.
- Produced hot water temperature can reach over 50°C. It can cause severe burns instantly or death form scalds. Children, disabled and elderly persons are at highest risk of being scalded. Feel water is necessary before bathing or showering. So, water temperature limiting valves are recommended.

⚠ CAUTIONS	
	<p>Very hot water. Burns or injury may occur.</p>

- Do not operate the unit with a wet hand; otherwise, an electric shock may be caused.
- The installation height of power supply should be over 1.8m, if there is any water spattered, separate the power supply from water.
- It is normal if some water drops from the hole of PTR valve during operation. But if there is a great amount of water, call the service agent for instruction.
After a long term use, check the unit base and fittings. If damaged, the unit may sink and result in injury.
- Arrange the drain pipe to ensure smooth draining. Improper drainage work may cause wetting of the building, furniture, etc.
- Do not touch the inner parts of the controller. Do not remove the front panel. Some parts inside are dangerous to touch, otherwise the unit malfunction may be caused.
- Do not turn off the power supply. System will stop or restart heating automatically during the standby mode. A continuous power supply for the unit is necessary, except service and maintenance.
- If the unit has not been used for a long period of time (2 weeks or more), hydrogen gas will be produced in the water piping system.
- Hydrogen gas is extremely flammable. To reduce the risk of injury under these conditions, it is recommended that open the hot water tap for several minutes at the kitchen sink before using any electrical appliance connected to the hot water system. When hydrogen is present, there will probably be an unusual sound such as air escaping through the pipe as the water begins to flow. There should be no smoking or open flame near the tap at the time it is open.

2. Preparations of installation

2.1 Transport

- In order to avoid scratch or deformation of the unit surface, please use guard boards to contacting surface.
- No contact of fingers and other things with the vanes.
- Do not incline the unit more than 15° to move. When install the unit, please keep the unit vertical.

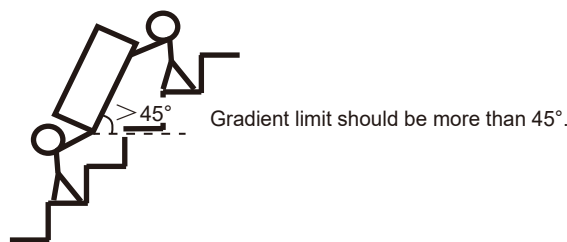

- Because the unit is very heavy, it needs two or more persons to carry the unit, and otherwise, it might cause injury and damage of the unit.

2.2 Packing list

Item	Quantity
Heat pump water heater	1
Installation & user manual	1
PTR valve	1
Condensation tube	1
Condensation tube joint	1

2.3 Installation site requirements

- Enough space for the unit installation and maintenance should be preserved.
- The surrounding of air inlet and outlet should be free from obstacles and strong wind.
- The base surface should be flat, surface should be inclined no more than 2° and able to bear the weight of the unit and suitable for installing the unit without increasing noise or vibration.
- The operation noise and air flow expelled shall not affect neighbors.
- No flammable gas is leaked nearby.
- It is convenient for piping and wiring.
- If it is installed in indoor space, it might cause indoor temperature decreased or noise. Please take preventive measures for this.
- If the unit has to be installed on a metal part of the building, make sure that the reliable electric insulation which should meet the relevant local electric standard.



CAUTION

- The ambient air temperature must also be considered when installing this unit, in heat pump mode the ambient air temperature must be above -7°C and below 40°C. If the ambient air temperature falls outside these upper and lower limits, the electrical elements will be activated to meet the hot water demand and the heat pump does not operate.
- The unit should be located in an area not subject to freezing temperatures. The unit located in unconditioned space (garages, basements, etc.) may require the water piping condensate piping, and drain piping to be insulated to shelter against freezing.
- When installing the unit in the following places, it may lead to the malfunction of the unit: (If it is inevitable, please consult with the unit supplier.)
 - The place contains mineral oils, for example, lubricant of cutting machines.
 - Seaside where the air contains salt.
 - Hot spring area where there are some corrosive gases like sulfide gas.
 - Factories where the high voltage power fluctuates seriously.
 - Inside a car or cabin.
 - The place with direct sunlight and other heat supplies. If it is not avoid, please install a covering or take other measurement.
 - Place where is contained by oil permeates like kitchen.
 - Strong electromagnetic wave surrounding.
 - The place filling with danger or flammable gases or materials.
 - The place filling with acid or alkali gases.



WARNING

- The unit must be securely installed; otherwise some noise and shaking may be produced.
 - Confirm that there is no any obstacle around the unit.
 - If there is strong wind like seashore, please fix the unit in the place where is protected from the wind.
-

2.4 Maintenance space requirements

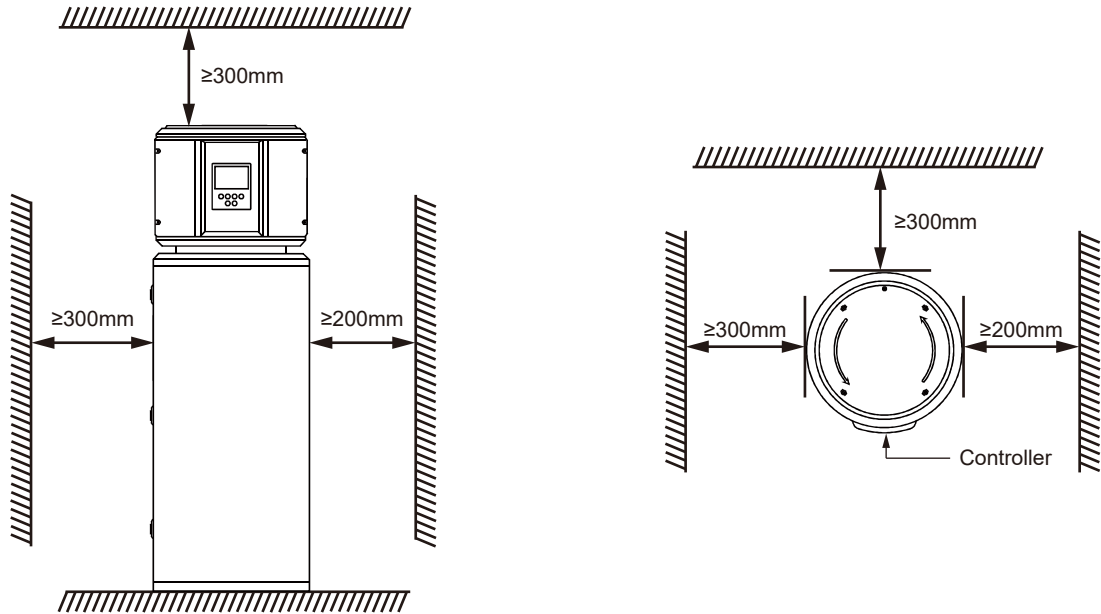

Note:

Top clearance is primarily a maintenance rather than operational requirement. If top clearance is reduced future maintenance (if required) cost may increase due to need to move and then return unit to original position.

2.5 Enclosed room installation

- SLA-R18-190D/N3A4: the minimum area = 25m³.
- SLA-R25-300D/N3D4: the minimum area = 32.5m³.
- SLA-R25-300D/N3D4C: the minimum area = 32.5m³.

2.6 Unit dimension

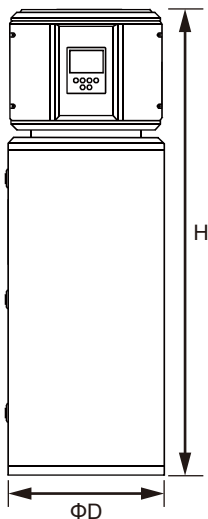

Model	D	H
SLA-R18-190D/N3A4	510mm	2175mm
SLA-R25-300D/N3D4	640mm	2010mm
SLA-R25-300D/N3D4C		

3. Installations

It is NECESSARY for installation to conform with AS/NZS 3500.4.



WARNING

Water quality requirements (chloride and pH):

- In areas of water supplies with high chloride levels, water can corrode certain parts, causing them to fail.
- Not suitable for heat pump units and storage tank units if the chloride content exceeds 200 mg/l.
- pH is a measure of whether water is alkaline or acidic.
- Heat pump units and hot water tank units with a pH value less than 6.0 are not guaranteed.
- The water supply to rainwater storage tanks within urban agglomerations can be corrosive due to the dissolution of atmospheric pollutants.

If the water heater is supplied with poor quality water, then it is necessary to install water softeners.

3.1 Water system piping diagram

SLA-R18-190D/N3A4

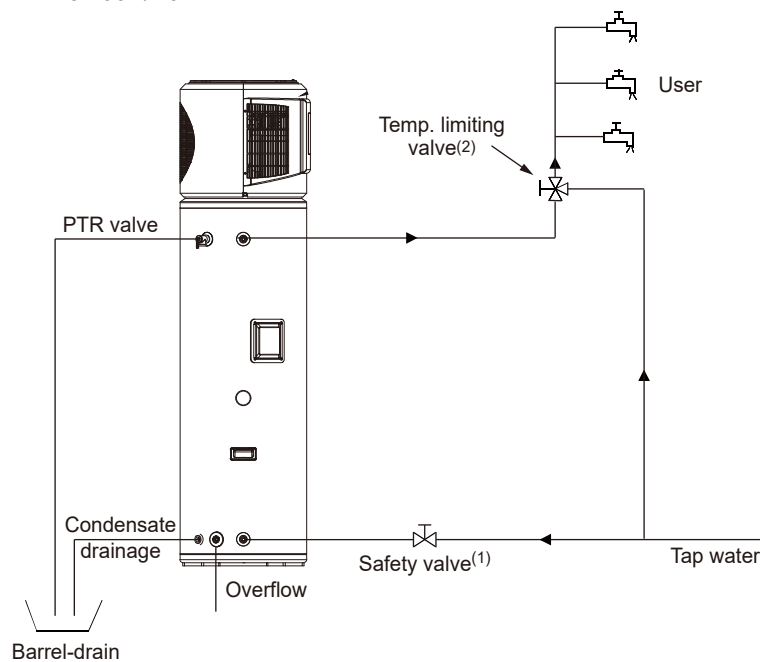

Notes:

- (1) The drainage pipe of the safety valve as accessories should be connect with the atmosphere.
- (2) The temperature limiting valve is required on the hot water usage terminal.

SLA-R25-300D/N3D4
SLA-R25-300D/N3D4C

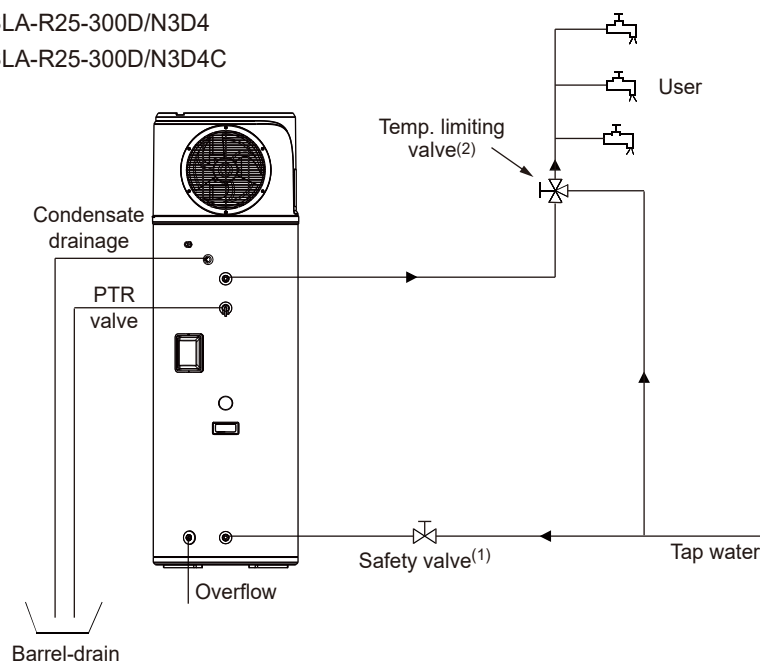

Notes:

- (1) The drainage pipe of the safety valve as accessories should be connect with the atmosphere.
- (2) The temperature limiting valve is required on the hot water usage terminal.



CAUTION

- Water piping system as the above figure. When install the unit at a place where outside temperature below freezing point, the insulation must be provided for all hydraulic components.
- The handle of PTR valve should be pulled out once per half a year to confirm that there is no jam of the valve. At the same time, please take care of hot water from the valve and burning.
- The outlet drain pipe should be insulated well in order to prevent water which is kept inside the pipe from freezing in cold conditions.

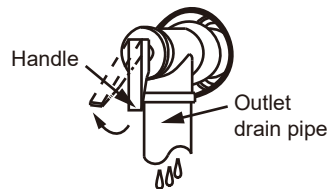

WARNING

It will cause explosion and injury, if do not comply with the following instruction:

- Do not dismantle the PTR valve.
- Do not block off the outlet drain pipe.

The specifications of water inlet and outlet pipes as following:

- SLA-R18-190D/N3A4: Internal thread (G3/4),
- SLA-R25-300D/N3D4, SLA-R25-300D/N3D4C: Internal thread (G3/4).
- Pipes must be heat-insulated well.

- After water system piping work, turn on the cold water inlet valve and hot water outlet valve and start effusing the tank. When water flow smoothly out from tap of water outlet, it means the tank is full. Please turn off all valves and check pipeline to make sure there is without any leakage.
- If the inlet water pressure is less than 0.15MPa, a pump should be installed at the water inlet pipe.
- For the safety usage of water tank at the condition of water supply pressure higher than 0.65MPa, a reducing valve should be installed at the water inlet pipe.
- Condensate may be leaked from the unit if condensate drainage pipe is blocked or it operates in high humidity environment, a drainage pan is recommended as shown as the following figure:

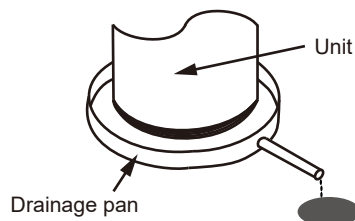

3.3 Condensate water drainage

To smoothly drain the condensate water, please install the unit at a horizontal floor. At the same time, please ensure the drainage joint is at the lowest level. Recommending the inclination angle of the unit to the ground should be no more than 2°.

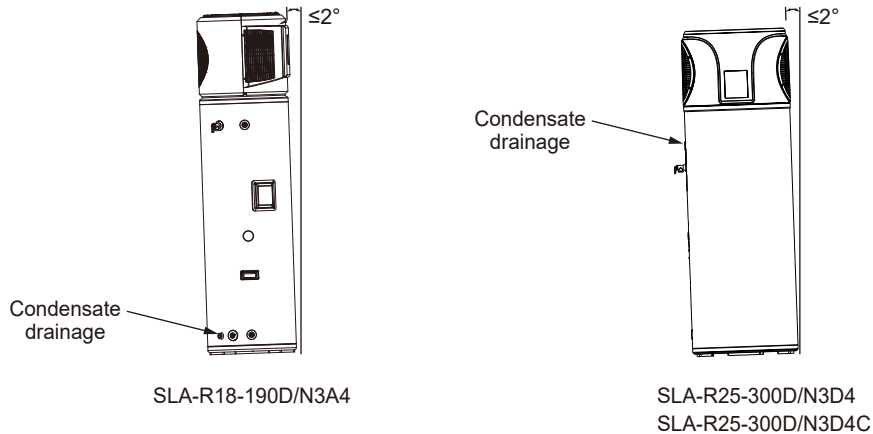

3.4 Electric connection



CAUTION

- The power supply should be an independent circuit with rated voltage.
- Power supply circuit should be earthed effectively. The wiring must be performed by professional technicians in accordance with national wiring regulations and the unit circuit diagram.
- An all-pole disconnection device which has at least 3mm separation distance in all poles and a residual current device (RCD) shall be incorporated in the fixed wiring according to the national rules.
- Set the electric leakage protector according to the relevant electric technical standards of the state.
- The power supply cord and signal cord shall be laid out neatly and properly without mutual interference or contacting the connection pipes.
- After wires connection, check it again and make sure the correctness before power on.

3.4.1 Electric wiring diagram

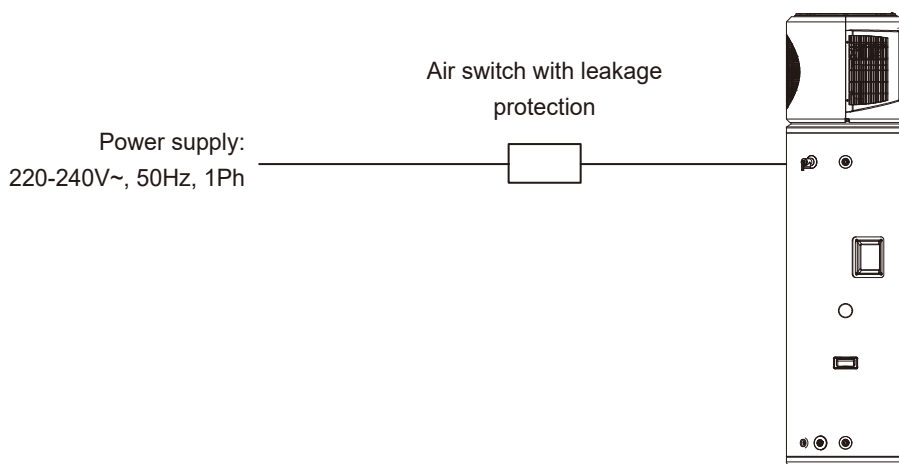

WARNING

- In order to ensure safety, the air switch with leakage protection must be installed at the external power supply box of the unit as shown above.
- This product can be used only when the grounding is confirmed to be reliable.

3.4.2 Specifications of power supply

	SLA-R18-190D/N3A4	SLA-R25-300D/N3D4	SLA-R25-300D/N3D4C
Power supply	220-240V~, 1Ph, 50Hz		
Min. diameter of power supply cord	2.5mm ²	2.5mm ²	
Earth cord	2.5mm ²	2.5mm ²	
Manual switch capacity / Fuse	30A / 30A	30A / 30A	
Creepage Breaker	30mA, ≤0.1Sec	30mA, ≤0.1Sec	

- Please choose the power supply cord according to the above table, and it should comply with local electric standard.
- The power supply cord model, recommended power supply cord is H05RN-F.



WARNING

The unit must be installed with a creepage breaker near the power supply and must be effectively earthed.

3.5 Installation checking

3.5.1 Location checking

- The flooring beneath the water heater must be able to support the weight of the unit when filled with water.
- Located indoors (such as a basement or garage) and in a vertical position. Sheltered from the freezing temperatures.
- Provisions made to shelter the area from water damage. Metal drain pan installed and piped to an adequate drain.
- Sufficient space to service the water heater.
- Sufficient air for the heat pump to function, the water heater must be located in a space which must have unrestricted air flow.



NOTES

For optimal efficiency and service ability, the following clearances should be maintained: 200/600mm on the air inlet side , 800mm on the air outlet side in the back.

- The unit cannot be placed into any type of closet or small enclosure.
- The site location must be free from any corrosive elements in the atmosphere such as sulfur, fluorine and chlorine. These elements are found in aerosol sprays, detergents, bleaches, cleaning solvents, air fresheners, paint and varnish removes, refrigerants and many other commercial and household products. In addition excessive dust and lint may affect the operation of the unit and require more frequent cleaning.
- The ambient air temperature must be above -7°C and below 40°C. If the ambient air temperature falls outside these upper and lower limits the electrical elements will be activated to meet the hot water demand.

3.5.2 Checking of the water system piping

- PTR valve (Temperature and pressure relief valve) properly installed with a discharge pipe run to an adequate drain and sheltered from freezing.
- All piping properly installed and free of leaks.
- Unit completely filled with water.
- Water temperature limit valve or mixer tap (Recommended) installed per manufacturer's instructions.

3.5.3 Checking of condensate drain pipe

- Must be located with access to an adequate drain or condensate pump.
- Condensate drain lines installed and piped to an adequate drain or condensate pump.

3.5.4 Checking of the electrical connections

- The water heater requires 220-240VAC for proper operation.
- Wiring size and connections comply with all local applicable codes and the requirements of this manual.
- Water heater and electrical supply are properly grounded.
- Proper overload fuse or circuit breaker protection installed.

3.5.5 Post installation review

- Understand how to use the controller to set the various parameters and functions.
- Understand the importance of routine inspection/maintenance of the condensate drain pan and lines. This is to help prevent any possible drain line blockage resulting into the condensate drain pan overflowing.
- IMPORTANT:** Water coming from the plastic shroud is an indicator that both condensation drain lines may be blocked. Immediate action is required.

4. Trial-running

4.1 Water affusion before operation

If the unit is used for the first time or used again after emptying the water tank, please make sure that the tank is full of water before turning on the power.

Method: please refer to the figure.

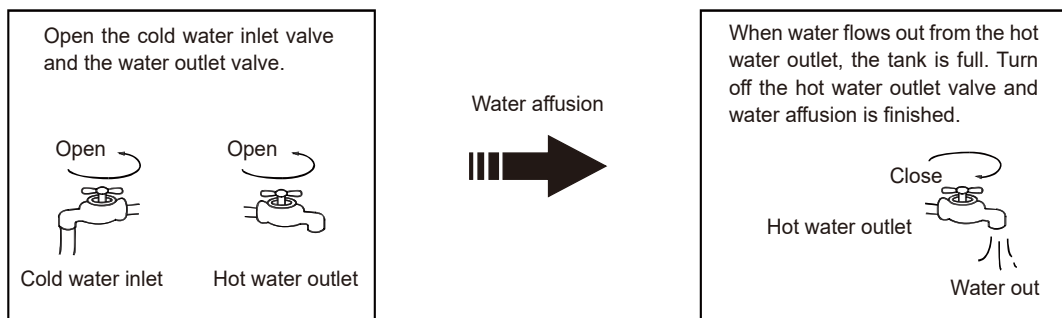

CAUTION

- Operation without water in water tank may result in the damage of the boost E-heater (electrical heater). Due to such damage, manufacturer will not be responsible for any damages caused by this issue.
- After powered on, the display lights up. Users can operate the unit through the buttons under the display.

4.2 Water emptying before operation

If the unit needs cleaning, moving, etc, the water tank should be emptied.

Method: please refer to the figure.

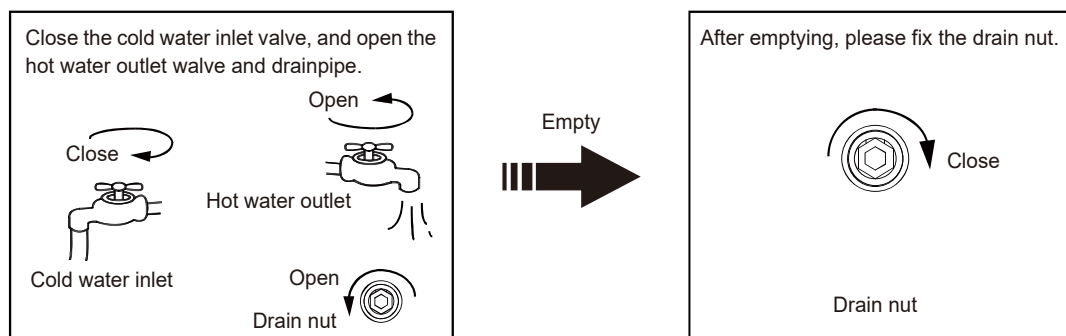

4.3 Trial-running

Checking list before commissioning:

- Correct installation of the system.
- Correct connection of the water and wiring.
- Condensate draining smoothly well insulation work for all hydraulic part.
- Correct power supply.
- No air in the water pipeline and all valves opened.
- Effective electric leakage protector installation.
- Sufficient inlet water pressure (Between 0.15MPa and 0.65MPa).

5. Operation

5.1 Controller panel explanation

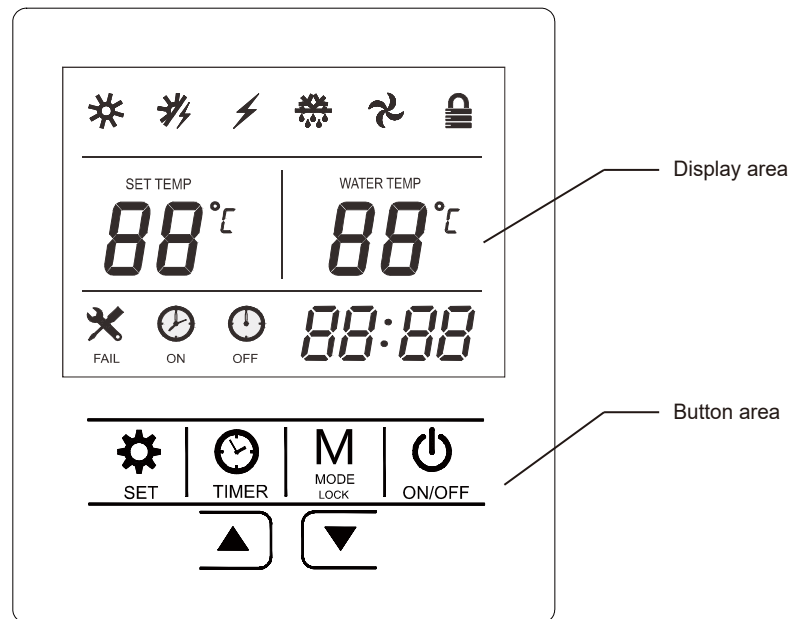







5.2 Explanation of icons

Icons	Explanations	Icons	Explanations
	Heat pump mode		Malfunction icon.
	Fast heating mode (heat pump + boost E-heater)		Timer on/Timer off icon.
	Electric heater mode		Clock icon.
	Defrost icon. Under the defrost mode, it will be lightened. Under the protection of the anti-freezing fuction, it will be flashed.		The setting value of water temperature
	Fan icon. It will be lightened, once the fan runs.		The current value of water temperature
	Lock icon.		

After the unit is powered on, the display screen will display all the icons for 3 seconds, and it will be display the regular interface automatically.

5.3 Explanation of buttons

Icons	Name
	Setting button
	Timer button
	Mode button

Icons	Name
	On/Off button
	Increase/up button
	Decrease/down button

5.3.1 On/Off button



In the unit standby state, press this button for 2 seconds to switch on the unit. When the unit is running, press it for 2 seconds to shutdown the unit.

5.3.2 Mode button



During the unit running, press mode button, and the unit will change the operating mode as following figure:

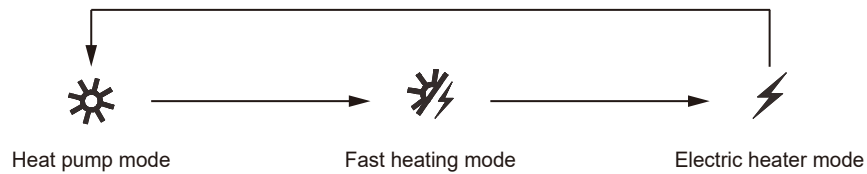

For these three mode, only under the heat pump mode, the boost electric heater will not be triggered.

During the unit running, after keep pressing the button for 3 seconds, all the buttons will be locked and the icon  will be displayed. Press it for 3 seconds again, the lock function will be canceled.

5.3.3 Set button



Press the set button, the running parameters of the unit will be display. Press the ▲ and ▼ buttons to change the parameter items.

Item	Explanation	Range of the parameter
A	Temperature of the lower water layer in tank	-20°C - 99°C
B	Temperature of the upper water layer in tank	-20°C - 99°C
C	Refrigerant temperature inside the coil	-20°C - 99°C
D	Suction temperature of the compressor	-20°C - 99°C
E	Outdoor ambient temperature	-20°C - 99°C
F	Running steps of the EXV	100 - 470
H	Discharge temperature of the compressor	0°C - 125°C

5.3.4 Timer button



Press the timer button to set the clock and timer on/off.

Clock setting -

Step 1: Press the Timer button to set the clock. So the hours of clock begins to flash.

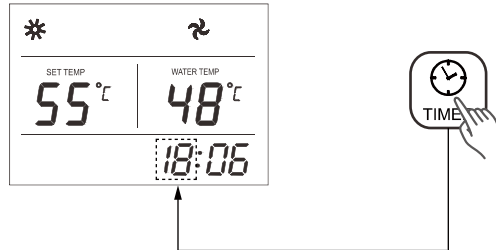

Step 2: Press Increase or Decrease button to set correct hours of clock. After setting the hours, press the Timer button again to begin to set the minutes of clock. So the minutes of clock begins to flash.

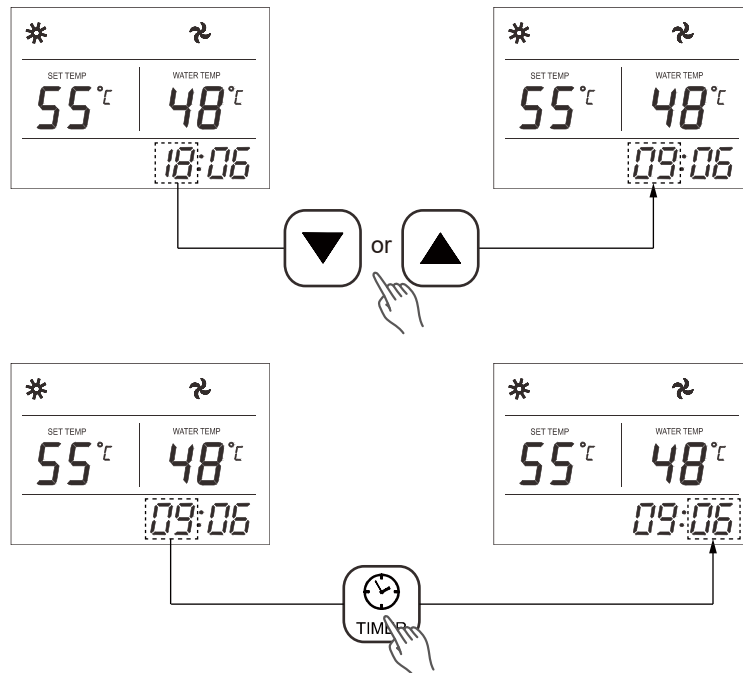

Step 3: Press Increase or Decrease button to set correct minutes of clock. Finally, press the timer button again to confirm and exit the clock setting.

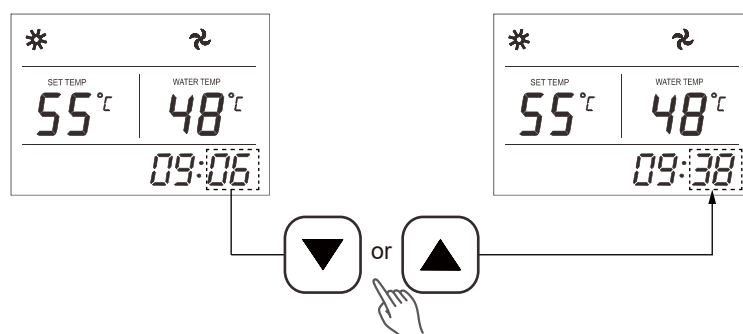

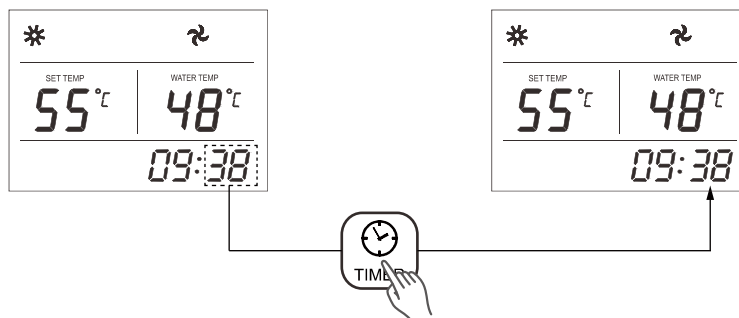

Timer setting -

Step 1: Keep pressing the Timer button for 5 seconds till the icon of timer on is flashed and the icon of timer off displayed. So timer on can be set now. At the same time, hours of timer on flashes.

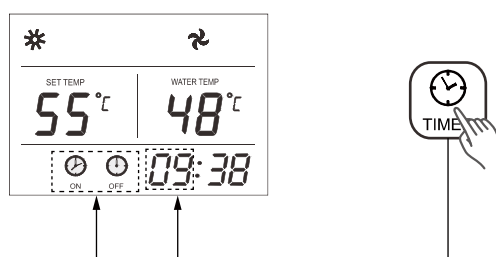

Step 2: Press Increase or Decrease button to set required hours of timer on. After setting the hours, press the Timer button again to begin to set the minutes of timer on. So the minutes begins to flash.
Notes: During the setting of timer on, the icon of timer on will keep flashing.

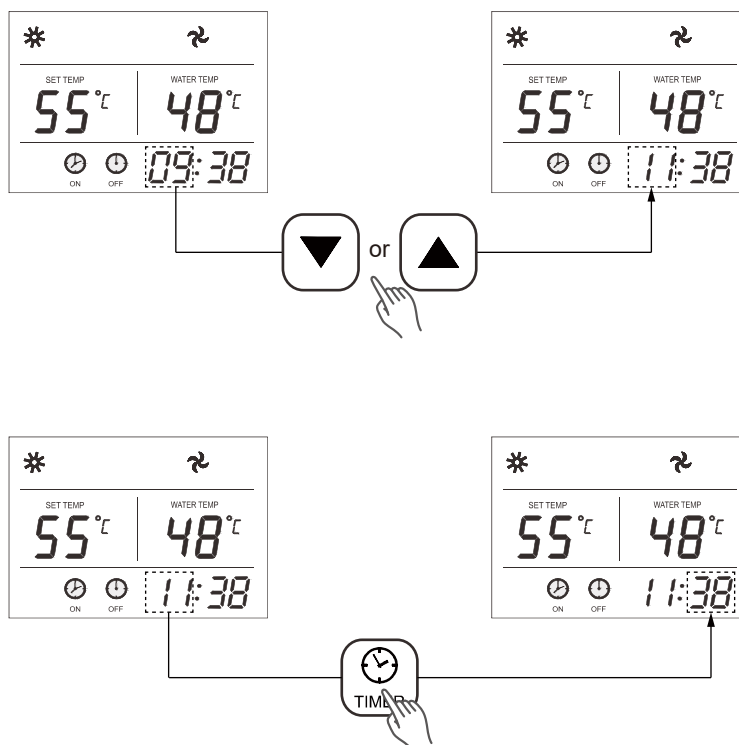

Step 3: Press Increase or Decrease button to set required minutes of timer on. Finally, press the Timer button again to confirm the timer on setting and begin to set timer off. At this time, the icon of timer off and hours of timer off will flashing.

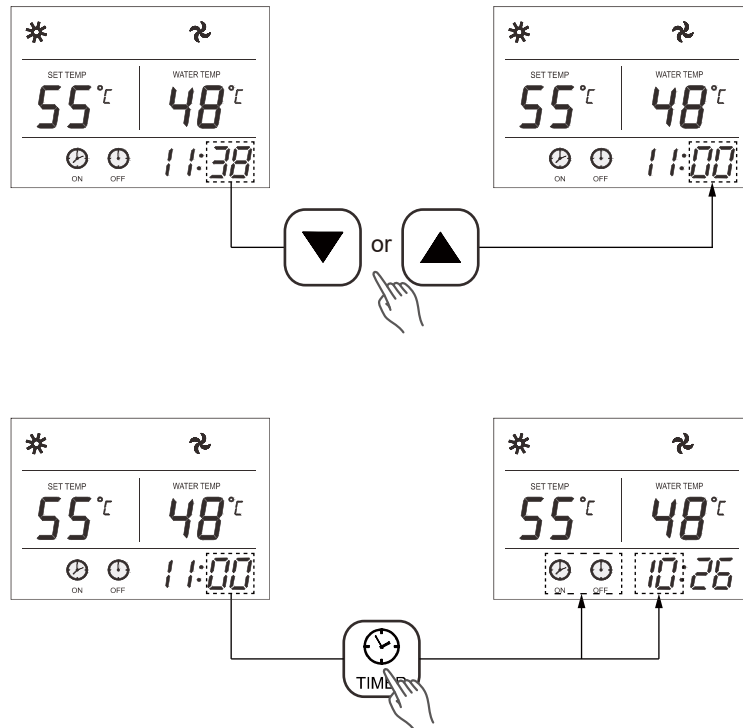

Step 4: Press Increase or Decrease button to set required hours of timer off. After setting the hours, press the Timer button again to begin to set the minutes of timer off. So the minutes begins to flash.
Notes: During the setting of timer off, the icon of timer off will keep flashing.

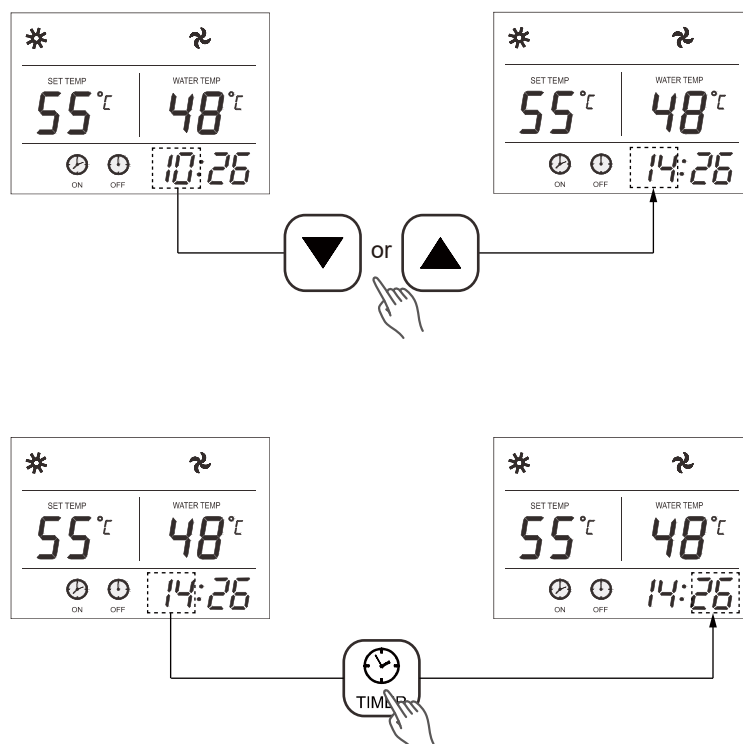

Step 3: Press Increase or Decrease button to set required minutes of timer off. Finally, press the Timer button again to confirm the timer off setting and exit the timer setting.

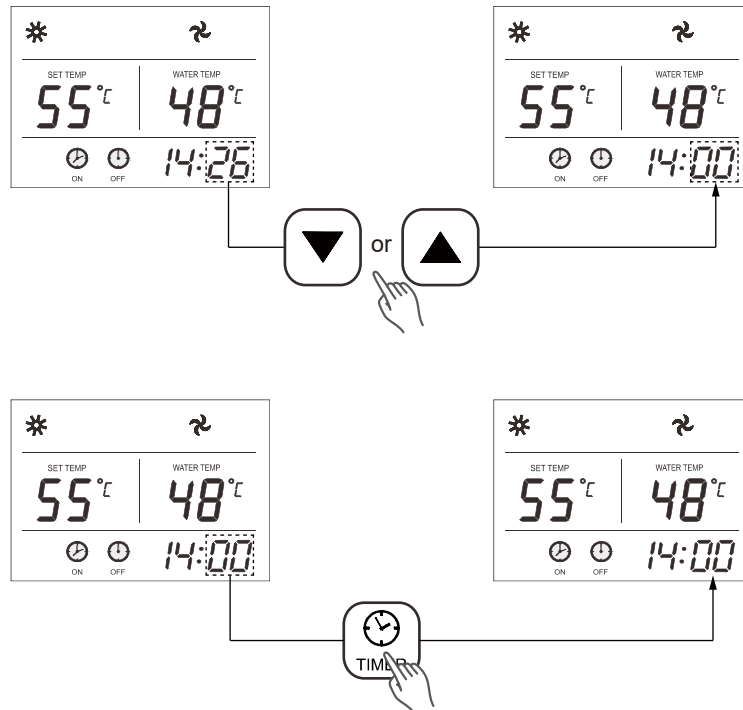

Notes: Once timer on/off is successfully set, the icons of timer on and off will be displayed.

Canceling timer setting -

In the process of timer on/off setting, press the Set button, and all the timer setting will be canceled.

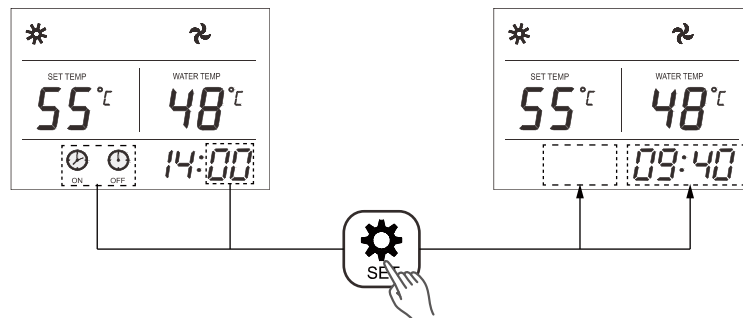

5.3.5 Increase/up button and Decrease/down button



These two buttons are used when the temperature setting, the clock setting and parameters query.

Under the running state of the unit, the water setting temperature can be raised by pressing the increase/up button, while the water setting temperature can be lowered by pressing the Decrease/down button.

5.3.6 Disinfect function

45% tank volume boosted to 60°C daily.

6. Troubleshooting

6.1 Non-error tips

Q: Why compressor cannot start immediately after setting?

A: Unit will wait for 3 minutes to balance the pressure of the refrigerant system before starting compressor again. It is a self protection logic of the unit.

Q: Why sometimes the temperature shown on the display decreased while unit is running?

A: When the temperature of layer water inside the tank is much higher than the bottom part, upper hot water will be mixed by the bottom cold water which is continually flow from the inlet tap water so that will decrease the water temperature of upper part .

Q: Why sometimes the temperature shown on the display decreased but the unit still keep off?

A: To avoid the unit turning on/off frequently, the unit will activate heat pump only when the water temperature in the bottom of the tank is lower than the setting temperature.

Q: Why sometimes the unit shows 'PA' on the display?

A: The heat pump available running ambient temperature is from -7°C to 40°C. If the ambient temperature is out of this range, the unit will show the PA to let user notice it.

Q: Why sometimes there is some water flowed from drainage pipe of PTR valve? (When the unit with PTR valve)

A: Because the water tank is pressure-bearable one, when water is heated inside the tank, water will expand, so the pressure inside the tank will increase. If the pressure goes up more than 1.0MPa, PTR valve will activate to relief the pressure and hot water drop will be discharged correspondingly. If water drop is continually discharged from PTR valve drainage pipe, it is abnormal, please contact qualified staff to repair.

6.2 Something about self-protection of unit

■ When the self-protection happens, the unit will be stopped and start self-check, and restart when the protection resolved.

■ In the following circumstance, self-protection may happen:

Air inlet or outlet is blocked;

The coil is covered with too much dust;

Incorrect power supply (Exceeding the range of 220-240V).

6.3 Error phenomenon shooting

Error phenomenon	Possible reason	Solution
Cold water tapped out and display screen extinguished	Bad connection between power supply plug and socket.	Plug in again.
	Setting water temperature is too low.	Set the water temperature higher.
	Temperature sensor or PCB is broken.	Contact service center.
No hot water tapped out	Public water supply is ceased.	Wait for water supply to recover.
	Cold water inlet pressure is too low. (less than 0.15MPa)	Wait for inlet water pressure increase.
	Cold water inlet valve is closed.	Open the water inlet valve.
Water leakage	Hydraulic pipeline joints are not sealed well.	Check and reseal all joints.

6.4 Error code shooting table

Code	Description	Corrective action
P01	Lower water temperature sensor error	Check connection to sensor
		Replace sensor if broken
		Replace PCB if broken
P02	Upper water temperature sensor error	Check connection to sensor
		Replace sensor if broken
		Replace PCB if broken
P03	Coil temperature sensor error	Check connection to sensor
		Replace sensor if broken
		Replace PCB if broken
P04	Suction temperature sensor error	Check connection to sensor
		Replace sensor if broken
		Replace PCB if broken
P05	Outdoor ambient temperature sensor error	Check connection to sensor
		Replace sensor if broken
		Replace PCB if broken
P06	Anti-freezing protection	This protection is normal. The unit which is under standby state will trigger this protection when the water tank sensor detects the water temperature is lower than 5°C.
P07	Discharge temperature sensor error	Check connection to sensor
		Replace sensor if broken
		Replace PCB if broken
E01	High pressure protection	Check connection to switch
		Replace switch if broken
		Check refrigerant system isn't blocked
		Check the refrigerant volume isn't too high
		Replace PCB if broken

Code	Description	Corrective action
E02	Low pressure protection	Check the low pressure switch connection is not well.
		Check if pressure switch is broken.
		Check if refrigerant system is block.
		Check for leakage in refrigerant system to repair
		Check refrigerant volume isn't too low
		Replace PCB if broken
E03	Over-heat protection (optional)	Check the connector
		Replace protector if broken
		Replace E-heater if broken.
		Replace water temperature sensors if broken.
E04	Over-high protection of discharge temperature	Replace PCB if broken
		Check if temperature sensor connection is not well.
		Check if discharge temperature sensor is broken.
		Check if the refrigerant system is block.
		Check if the refrigerant is too much.
E04	Over-high protection of discharge temperature	Replace PCB if broken
		Check if temperature sensor connection is not well.
		Check if discharge temperature sensor is broken.
		Check if the refrigerant system is block.
		Check if the refrigerant is too much.
PA	It is normal and no need repair. The heat pump available running ambient temperature is from -7°C to 40°C. If the ambient temperature is out of this range, the unit will show the PA to let user notice it. During this period, the boost electrical heater can be used.	
E08	Communication error	Check connection between PCB and controller if its broken
		Replace the controller is broken.
		Replace the PCB if its block.

NOTE

- The diagnostic codes listed above are the most common. If a diagnostic code not listed above is displayed, please contact residential technical assistance.
- If any of E01/E02/E04 continuously appear 3 times within 30 minutes, the unit will consider it as heat pump system error, and the unit will stop running. The unit will not run until the power supply is reset.

7. Maintenance

7.1 Maintenance

- Check the connection between power supply plug, socket and ground wiring regularly.
- In some cold area (below 0°C), if the unit will be stopped for a long time, all the water should be released in case of freezing of inner tank and damage of boost electrical heater.
- It is recommended to clean the inner tank and boost E-heater every half year to keep an efficient performance.
- Check the anode rod every half year and change it, if it has been used out. For more details, please contact the supplier or the after-sale service.
- It is recommended to set a lower temperature to decrease the heat release, prevent scale and save energy if the outlet water volume is sufficient.
- Before shutting the system off for a long time, please:
Shut off the power supply;
Release all the water in the water tank and the pipeline. Close all the valves;

Check the inner components regularly.

7.2 How to change the anode rod

- Turn off the power supply, and turn off the water inlet valve.
- Open hot water tap, and decrease the pressure of the inner tank.
- Open the drainage valve, and drain out the water, until there are no water flow out.
- Remove the cover / panel of top part, and take out the anode rod.
- Replace it with a new one, and make sure effective sealed.
- Open cold water inlet tap until water flows out from outlet tap then close water outlet tap.
- Power on and restart the unit.

7.3 Recommended regular maintenance table

Item	Checking content	Check frequency	Action
1	anode rod	Every 6 months	Replace it if it has been used out.
2	Inner tank	Every 6 months	Clean the tank.
3	Boost E-heater	Every 6 months	Clean E-heater.
4	PTR valve	Every 1 year	Operate the handle of the PTR valve to ensure that water can be flowed out.
		If water does not flow freely when operating the handle, replace PTR valve with a new one.	

8. Specifications

Model	SLA-R18-190D/N3A4	SLA-R25-300D/N3D4 SLA-R25-300D/N3D4C
Power supply	220-240V~, 50Hz, 1Ph	
Running ambient air Temp.	-7°C - 40°C	-7°C - 40°C
Rated water supply pressure	800kPa	800kPa
PTR valve setting	850kPa	850kPa
Rated power input (Heat pump)	465W	610W
Heating capacity	1700W	2500W
Max. input power / current	2615W / 11.89A	2863W / 13.02A
Outlet water Temp.	35°C - 65°C	35°C - 65°C
Water connection size	G3/4"	G3/4"
Operation pressure (High / Low)	4.4MPa / 0.6MPa	4.4MPa / 0.6MPa
IP data	IPX4	IPX4

The dates of rated power input (Heat pump) and heating capacity are based on the condition:
Inlet water from 14°C to 55°C; Air 19°CDB/15°CWB.

Document Version History

Version	Amendments	Effective Date
1.0	First Release	June 2022
1.1	<ul style="list-style-type: none">• Free space required around the heat pump for maintenance have been decreased• Minimum volume required for an installation to be done in an enclosed room have been added• Slight change in the specifications of the heat pumps• Multiple minor amendments have been made to the previous document	August 2022
2.0	<ul style="list-style-type: none">• A new commercial heat pump has been added to our portfolio• Description of Error Code E02 has been amended	October 2022
3.0	<ul style="list-style-type: none">• Detailed description of the timer button has been added	February 2023
3.1	<ul style="list-style-type: none">• Display button lock/unlock instruction has been updated	June 2023